

Installation Instruction

HLSD180 (1/2-in), ELSD180 (3/8-in) or QLSD180 (1/4-in)

WARNING: This is tempered glass. When working with glass, protect the edges at all times. Do not set the edge of the glass directly on any hard surface. Protect all of the edges from impact with with hard surface or object.

WARNING: To avoid damage to the finish of this deluxe enclosure, use only mild cleaners. Always read the label on the cleaner to be used. Do not use harsh chemicals or abrasive cleaners.

We recommend two person installation.

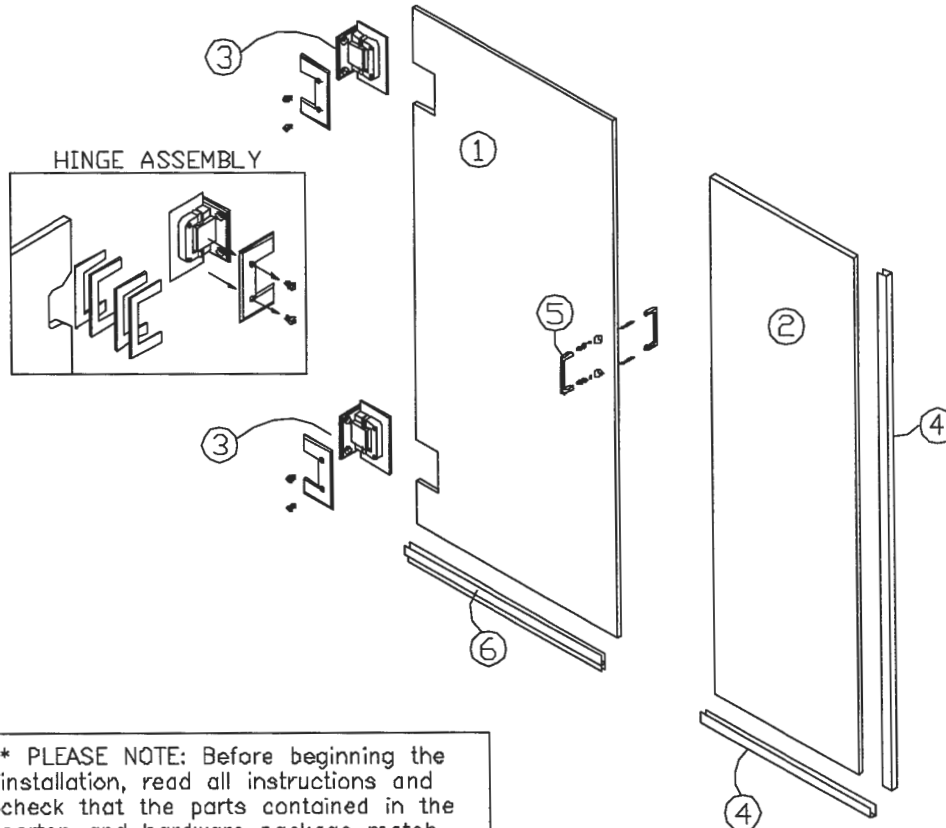

* PLEASE NOTE: Before beginning the installation, read all instructions and check that the parts contained in the carton and hardware package match those parts listed below. If you should find any discrepancies please contact HOLCAM SALES at 800-843-3332





TOOLS REQUIRED

1. Tube of approved bathroom silicone sealant
2. 5/32" allenhead wrench
3. Philips head screwdriver
4. Wood Blocks
5. Mill File
6. Drill motor w/ (3/16, 1/4" 9/64" drill bits)
7. Painters masking tape
8. Hacksaw
9. Level

PARTS LIST

1. Glass Door
2. Glass Panel
3. EuroLite Hinge Assembly w/ required rubber shims
4. U-Channel
5. 6" Handle to Handle
6. Vinyl Sweep

ASSEMBLY HARDWARE

ITEM	NAME	QTY.
1.	 10 x 2" Screws	
2.	 8 x 1 1/2" Screws	
3.	 Plastic Anchor	
4.	 3/8" U-Channel	
5.	Adjusting Blocks	

Installation Instruction

HLSD180 (1/2-in), ELSD180 (3/8-in) or QLSD180 (1/4-in)

1. MARK CENTERLINE OF SILL LIGHTLY IN PENCIL.

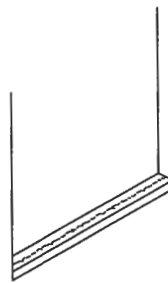

2. POSITION BOTTOM CHANNEL CENTERED ON SILL, BUTTED UP TO THE WALL. MARK HOLE LOCATIONS. DRILL 3/16" HOLES AND INSERT THE PLASTIC ANCHORS. PLACE A DAB OF SILICONE IN ANCHORS AND SECURE CHANNEL TO SILL WITH #8 x 1 1/2" SCREWS.

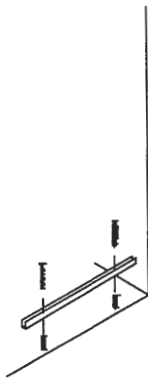

3. POSITION WALL CHANNEL CENTERED ABOVE THE BOTTOM CHANNEL. PLUMB AND MARK HOLE LOCATIONS. DRILL 3/16" HOLES AND INSERT THE PLASTIC ANCHORS. SECURE CHANNEL TO WALL WITH #8 x 1 1/2" SCREWS.

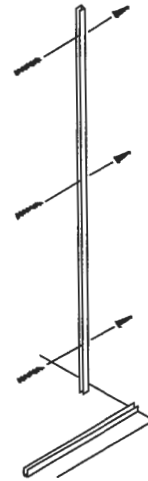

4. PLACE SETTING BLOCKS INSIDE BOTTOM U-CHANNEL. TEST FIT PANEL GLASS, ADD OR SUBTRACT SETTING BLOCKS UNTIL THE PANEL GLASS IS EVEN WITH THE TOP OF THE WALL CHANNEL. ADJUST THE GLASS 1/16" OUT OF THE END OF THE BOTTOM CHANNEL. THE CORRECT SPACING FOR THE DOOR IS DOOR GLASS + 3/8".

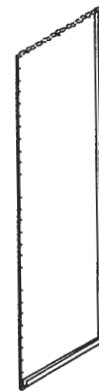
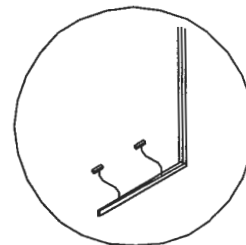
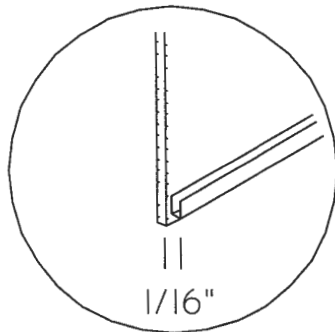

Installation Instruction

HLSD180 (1/2-in), ELSD180 (3/8-in) or QLSD180 (1/4-in)

5. PLACE 1/2" BLOCKS ALONG SILL TO SET DOOR GLASS ON. ALIGN DOOR ASSEMBLY WITH THE PANEL, CHECK DOOR FOR PLUMB CONDITION. MARK MOUNTING HOLE LOCATIONS. REMOVE DOOR ASSEMBLY AND THEN REMOVE THE HINGES FROM THE GLASS. USING A 1/4" DRILL BIT, DRILL THROUGH THE FINISH WALL MATERIAL ONLY. THEN USING A 9/64" DRILL BIT DRILL PILOT HOLES, CENTERED IN THE 1/4" HOLES. SECURE HINGE TO WALL WITH #10X2" WOOD SCREW. REINSTALL THE GLASS IN THE HINGES, FOLLOW THE TIGHTENING SEQUENCE AS SHOWN.

HINGE ASSEMBLY

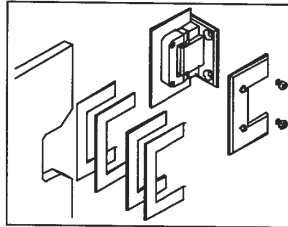

NOTE:

TAPING THE FACE OF THE HINGES DURING INSTALLATION WILL HELP PREVENT DAMAGE.

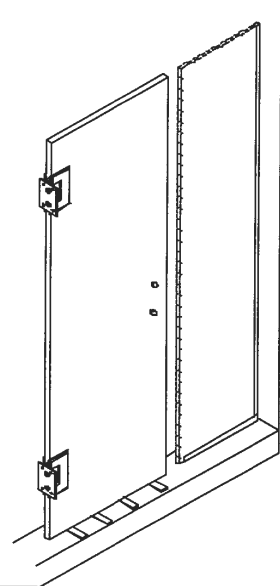

6. INSTALL HANDLE ASSEMBLY THROUGH HOLE IN GLASS USING PLASTIC SHIMS AND WASHERS. RUN A SMALL CONTINUOUS BEAD OF SILICONE ON BOTH SIDES OF STATIONARY PANEL WHERE THE U-CHANNEL AND GLASS MEET. ALLOW SILICONE TO CURE FOR TWENTY FOUR HOURS BEFORE USING SHOWER.

7. MEASURE THE DOOR GLASS ALONG THE BOTTOM EDGE. CUT THE VINYL SWEEP TO SIZE. INSTALL THE SWEEP OVER THE BOTTOM EDGE OF THE DOOR GLASS.

